

Data Sheet



Article number: 2314451401

Description: E+G Cast iron wheel 451401
RE.F4-100-RBL - loose wheel

Measures

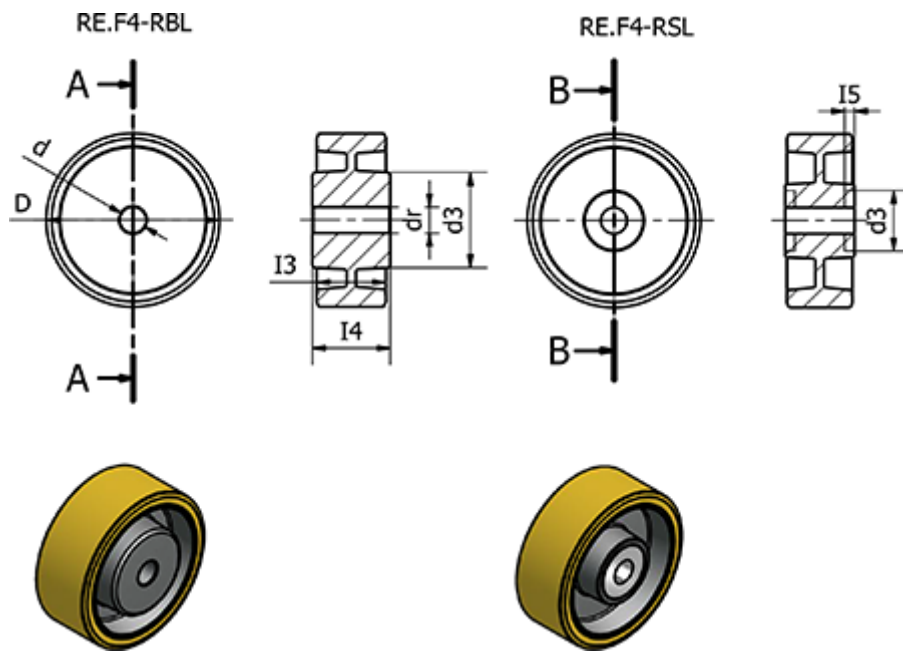

Code	= 451401	Max static load (N)	= 5000
d	= 100	Rolling resistance (N)	= -
d3	= 55	Type	= RE.F4-100-RBL
dr	= 30	Weight (g)	= 1500
Dynamic carrying capacity (N)	= 3000		
I3	= 40		
I4	= 45		
I5	= -		